



Interface Module User Guide



Features

- Two Programmable Inputs
- Alarm status Output
- 10A relay output with programmable ON delay

Contents

1	Pairing the Interface module	2
2	Wiring Diagrams.....	3
2.1	Remote receiver to Arm/Disarm the Kwêbeam system	3
2.2	Connecting a LED to indicate the alarm state.....	3
2.3	Connecting switches to monitor Alarm and Tamper signals	4
2.4	Monitor external devices for Alarm and Tamper signals.....	4
2.5	Installing a Siren or LED spot light.....	5
2.5.1	Changing the ON delay of the relay output	5
2.6	Wiring the Kwêbeam system to an existing alarm panel	6
3	Input & Output configuration options.....	7
3.1	Changing the ON delay of the relay output	7
3.2	Changing INPUT & OUTPUT settings.....	7

1 Pairing the Interface module

Pull notch on side to open

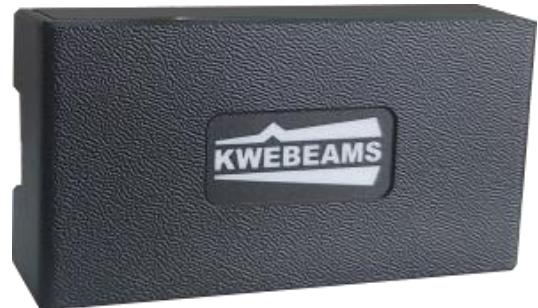

- Make sure the system is NOT armed.
- Connect the Keypad to the Programming Socket with the supplied cable.

- Press  to show the current Zone.
- Select **Zone 1 – 8**.

- Press & Hold  to save the ZONE.

- LED  will illuminate to indicate successful pairing.

Note: The Interface Module can also be programmed as **ZONE 9** (Base or Main Unit of the system). All Keypads & Sensors must be reprogrammed if the Module is programmed as **ZONE 9** (See Kwêbeam_User_Manual).

2 Wiring Diagrams

2.1 Remote receiver to Arm/Disarm the Kwêbeam system

- Make sure the system is NOT armed.
- Connect the Keypad to the Programming Socket with the supplied cable.

- Press  to show the current Settings.
- Make sure the following keys are selected: **2, 4, 5, 7**

- Press & Hold  to save the Settings.
- A second long “beep” will indicate a successful save.

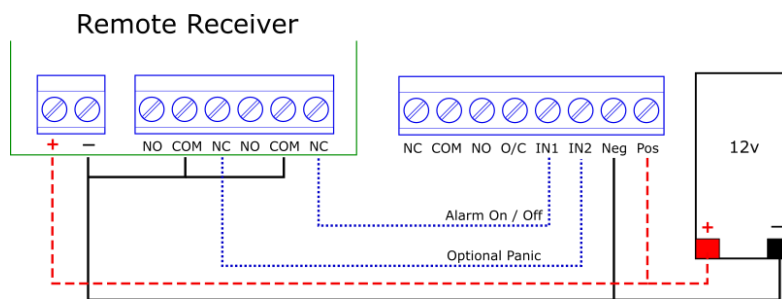

Note: Set the outputs on the remote receiver to toggle mode (latch momentarily).
IN2 will sound all built-in sirens for 20 seconds when pulsed. This input is optional and can be left unconnected if not needed.

2.2 Connecting a LED to indicate the alarm state

The O/C output is an Open Collector output with a constant 10mA current limit. Any LED can be directly connected without any series resistor.

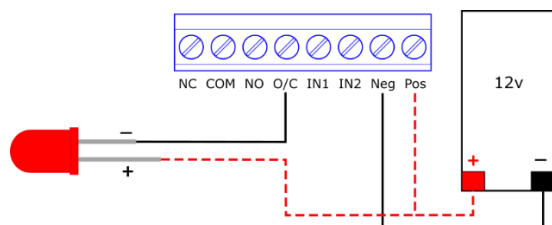

2.3 Connecting switches to monitor Alarm and Tamper signals

- Make sure the system is NOT armed.
- Connect the Keypad to the Programming Socket with the supplied cable.



- Press  to show the current Settings.
- Make sure the following keys are selected: **3, 4, 5**



- Press & Hold  to save the Settings.
- A second long “beep” will indicate a successful save.

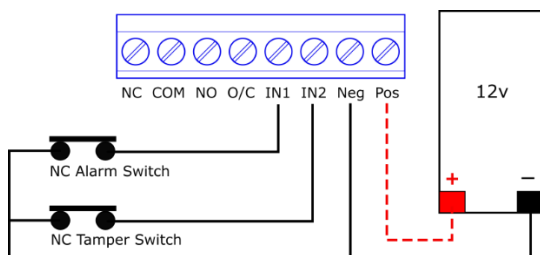

IN1 will report an Alarm signal if the switch opens while the system is armed.
 IN2 will report a Tamper signal if the switch opens (irrespective of the alarm status)

2.4 Monitor external devices for Alarm and Tamper signals

- Make sure the system is NOT armed.
- Connect the Keypad to the Programming Socket with the supplied cable.



- Press  to show the current Settings.
- Make sure the following keys are selected: **3, 4, 5**



- Press & Hold  to save the Settings.
- A second long “beep” will indicate a successful save.

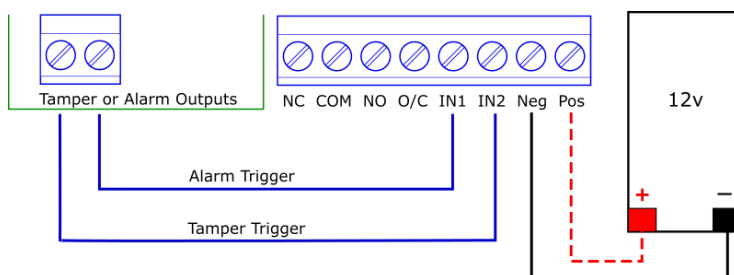

IN1 will report an alarm signal if the input changes from a **Low to High** state while the system is armed. IN1 can also be programmed to report an alarm signal if the input changes from a **High to Low** state (Select only key **3** under option **P3**).

IN2 will report a Tamper signal if the input changes from a **Low to High** state

2.5 Installing a Siren or LED spot light

- Make sure the system is NOT armed.
- Connect the Keypad to the Programming Socket with the supplied cable.

- Press  to show the current Settings.

- Make sure the following keys are selected: **2, 4, 5**

- Press & Hold  to save the Settings.

- A second long “beep” will indicate a successful save.

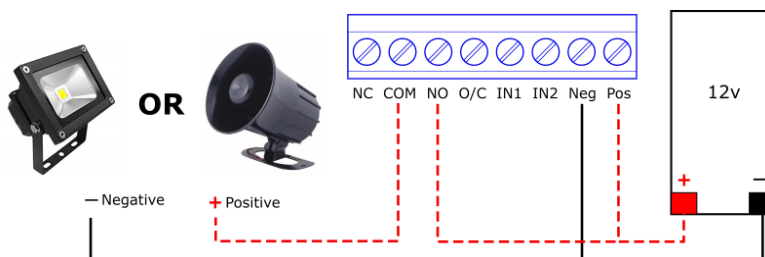

2.5.1 Changing the ON delay of the relay output

- Press  to show the current delay for the relay output.

- Press key 1 – 8 to select the new ON delay:

- | | |
|----------------|---------------|
| 1 = 1 second | 5 = 1 minute |
| 2 = 2 seconds | 6 = 2 minutes |
| 3 = 10 seconds | 7 = 3 minutes |
| 4 = 30 seconds | 8 = 5 minutes |

- Press & Hold  to save the new setting.

- A second long “beep” will indicate a successful save.

2.6 Wiring the Kwêbeam system to an existing alarm panel

- Make sure the system is NOT armed.
- Connect the Keypad to the Programming Socket with the supplied cable.



- Press  to show the current Settings.
- Make sure the following keys are selected: **1, 4, 5, 7**



- Press & Hold  to save the Settings.
- A second long “beep” will indicate a successful save.

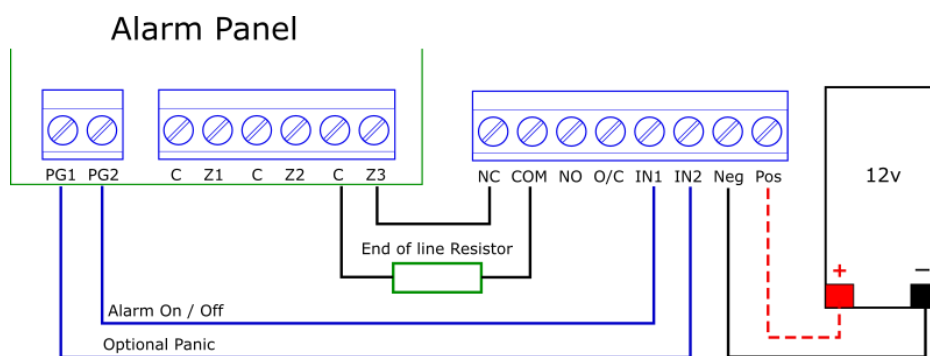

IN1 must be latched in a **High** state for the system to be armed. IN1 can also be programmed to arm the system while the input is **Low** (Select keys **1, 5, 7** under option **P3**).

IN2 will sound all built-in sirens for 20 seconds when pulsed. This input is optional and can be left unconnected if not needed.

3 Input & Output configuration options

- Make sure the system is NOT armed.
- Connect the Keypad to the Programming Port with the supplied cable.

3.1 Changing the ON delay of the relay output



- Press  to show the current delay for the relay output.
- Press key 1 – 8 to select the new ON delay:

1 = 1 second	5 = 1 minute
2 = 2 seconds	6 = 2 minutes
3 = 10 seconds	7 = 3 minutes
5 = 30 seconds	8 = 5 minutes



- Press & Hold  to save the new setting.
- A second long “beep” will indicate a successful save.

3.2 Changing INPUT & OUTPUT settings



- Press  to show current selection.
- Press key 1 – 3 to program a function for IN1.
 - Key 1 – Arm / Disarm with a latched input.
 - Key 2 – Arm / Disarm with a pulsed input.
 - Key 3 – Send an alarm signal when the input is pulsed.
- Key **4, 5 & 7** can be selected / deselected for the desired application.

Key 4 on: IN1 triggers when the state changes from **Low to High**

Key 4 off: IN1 triggers when the state changes from **High to Low**

Key 5 on: The output relay is enabled when the system is armed from a Keypad or any external device connected to IN1.

Key 5 off: The output relay is **ONLY** enabled when armed from an external device connected to the IN1.

Key 7 on: When IN2 changes from a **Low to High** state all built-in Sirens will sound for 20 seconds.

Key 7 off: IN2 will report a Tamper signal when the input changes from a **Low to High** state (irrespective of the alarm status)



- Press & Hold  to save the new settings.
- A second long “beep” will indicate a successful save.